

Article number: 50310402

Description: Open pillow block PMN 40 E  
FM standard bearing included

## Measures

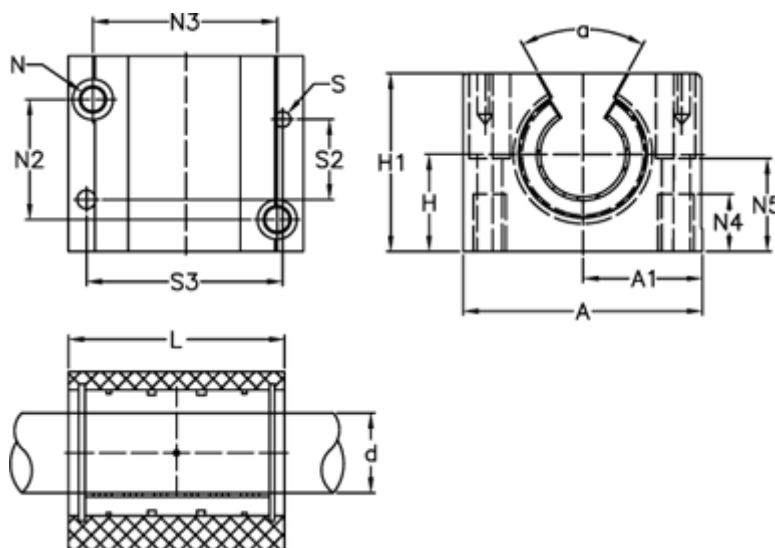

A = 108	N3 = 86.00
a = 60 degrees	N4 = 26
A1 = 54.0	N5 = 44.0
H = 45	S = 8
H1 = 77	S2 = 35
L = 91	S3 = 90
N = M12 x 1,75	Static load (kg) = 3360
N2 = 58.00	Weight (kg) = 1.000